



MODULES
À L'UNITÉ
ET
ACCESSOIRES

Create
your own path
with Brick Elite
Parkour Equipment

NOTICE DE MONTAGE



brick

brick

SOMMAIRE

LES MODULES À L'UNITÉ **1**

Module Stud	1
-------------	---

Module Tower	2
--------------	---

Module High Tower	3
-------------------	---

Module Wall	4
-------------	---

Module High Wall	5
------------------	---

Module Trapeze Wall	6
---------------------	---

Module L Wall	7
---------------	---

Module Precision Beam	8
-----------------------	---

LES ACCESSOIRES **9**

Assembly Key	9
--------------	---

Key Handle L	10
--------------	----

STUD

Réf.
00160100

Dimensions (mm)
445 x 660 x 200

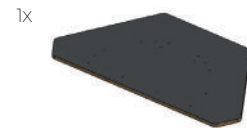
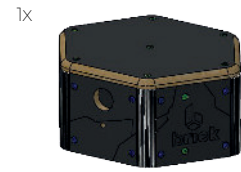
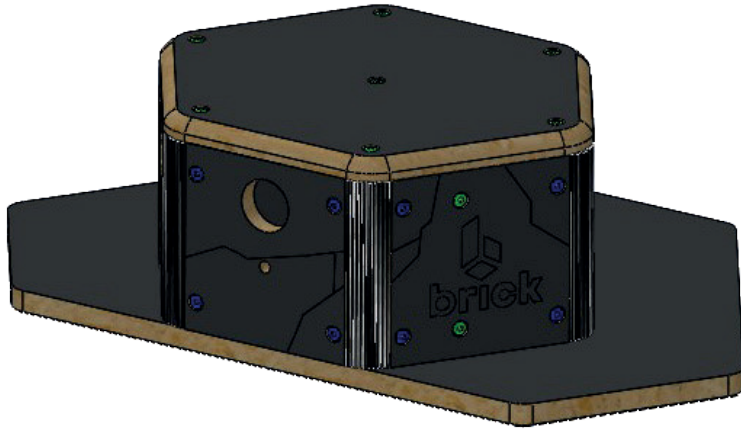

1

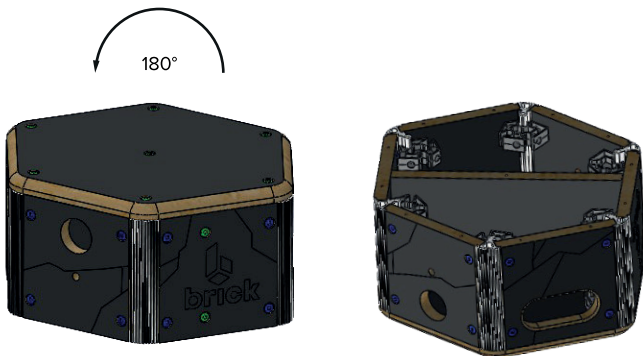

2

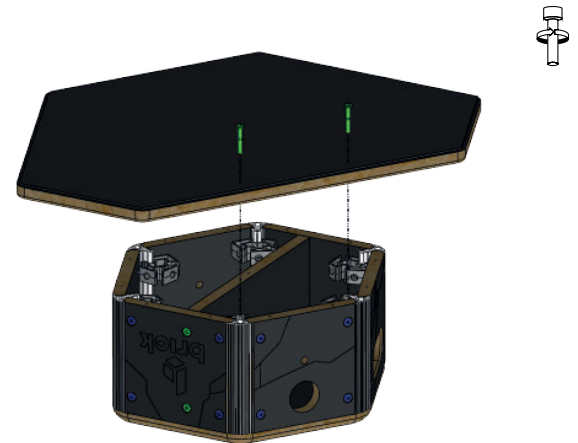

3

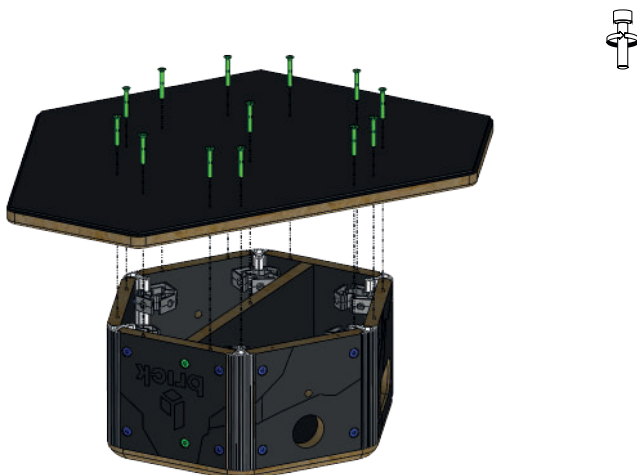

4

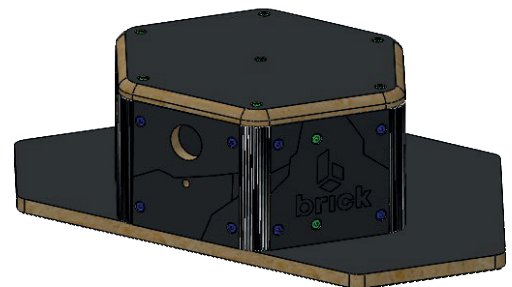

TOWER

Réf.
00010100

Dimensions (mm)
650 x 950 x 560

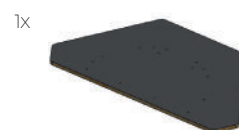

1



2

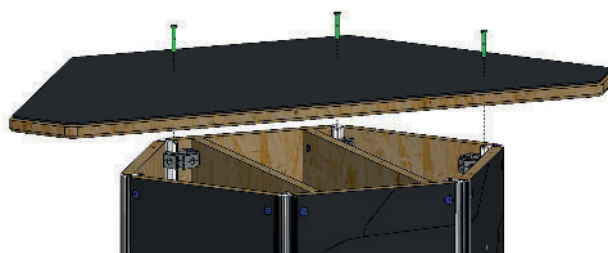

3



4



HIGH TOWER

Ref.
00040100

Dimensions (mm)
650 x 950 x 956

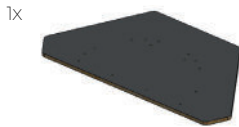

1



2

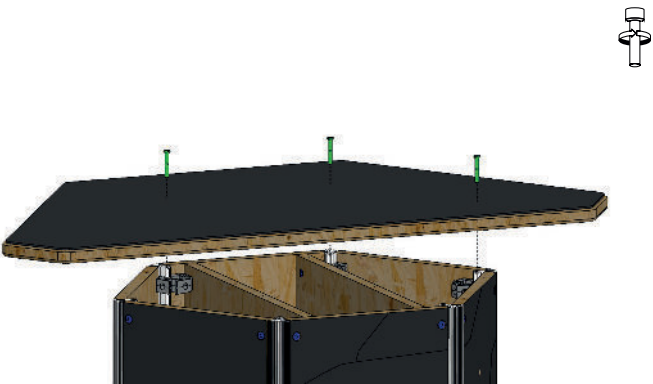

3



4



WALL

Réf.
00020100

Dimensions (mm)
1300 x 612 x 560



1



2

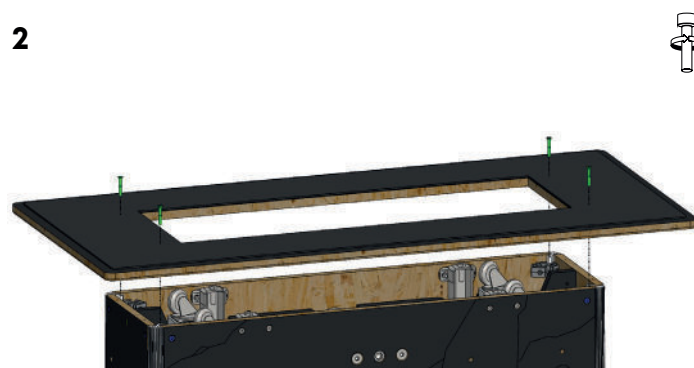

3



4

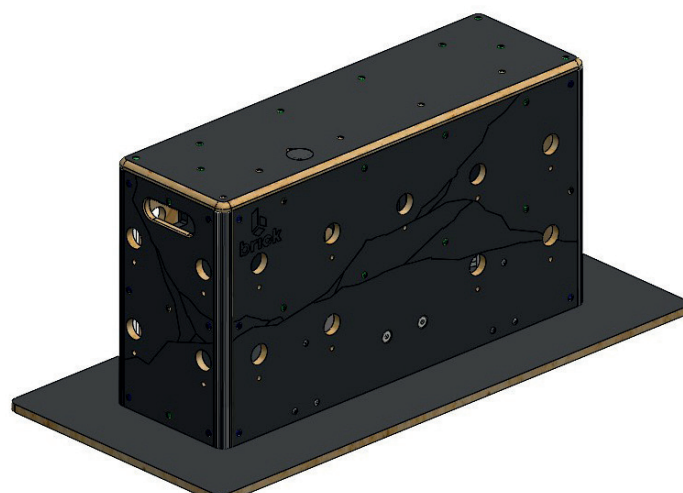

HIGH WALL

Réf.
00030100

Dimensions (mm)
1300 x 612 x 956

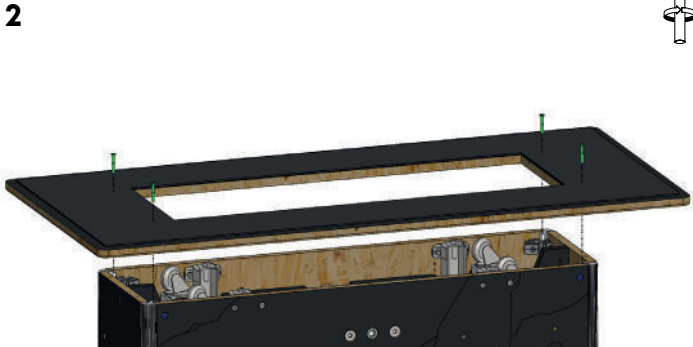

TRAPEZE WALL

Réf.
00090100

Dimensions (mm)
738 x 1320 x 956

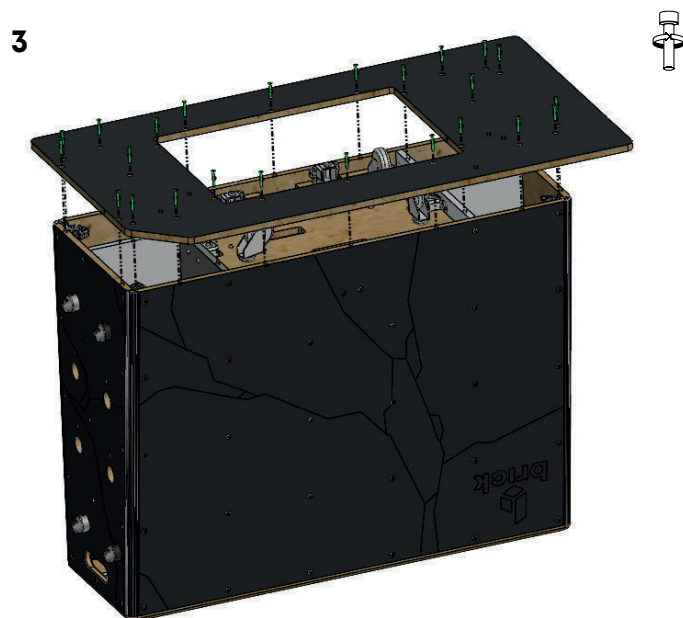
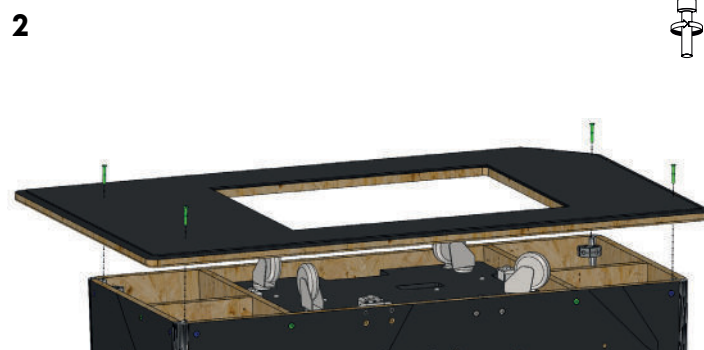

L WALL

Réf.
00080100

Dimensions (mm)
1320 x 1940 x 956

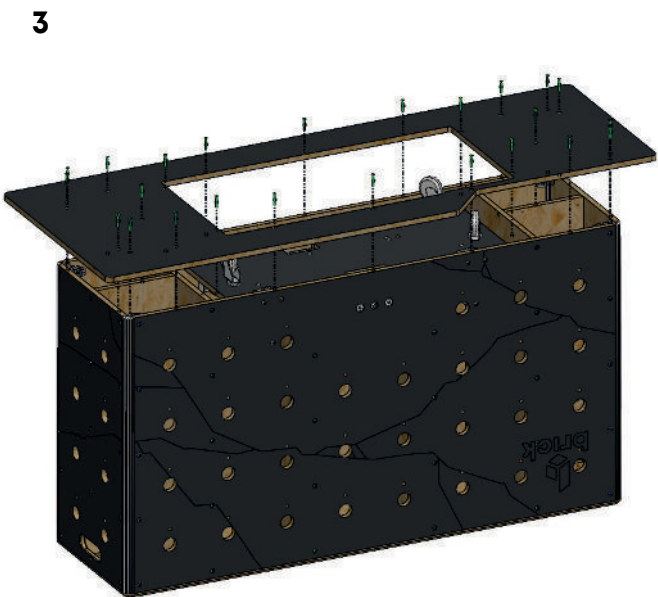
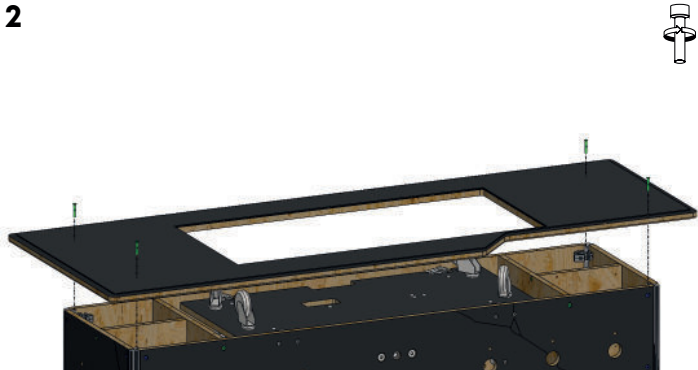

PRECISION BEAM

Réf.
00110100

Dimensions (mm)
800 x 175 x 200

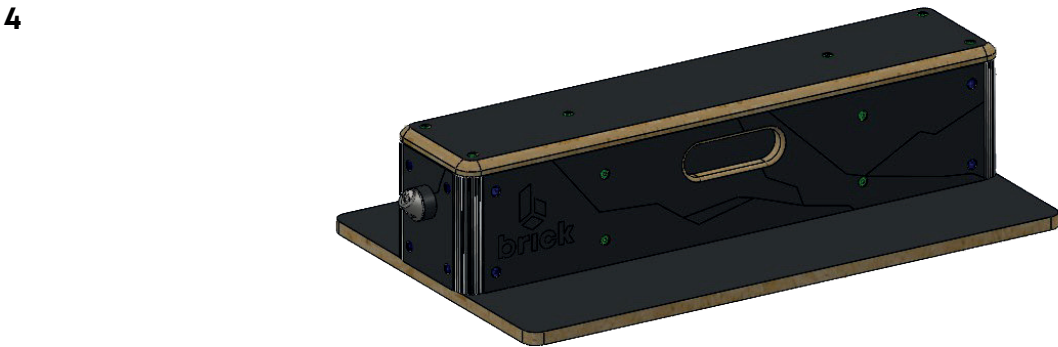
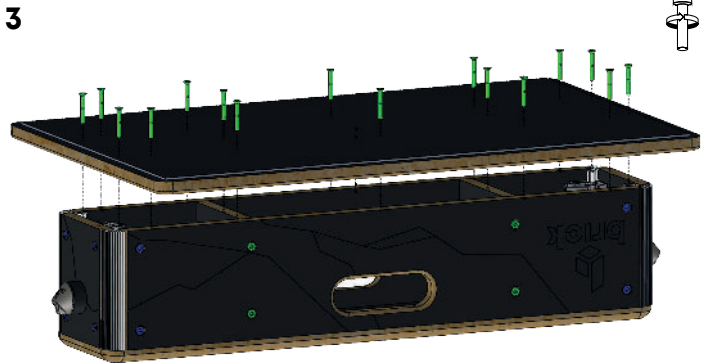
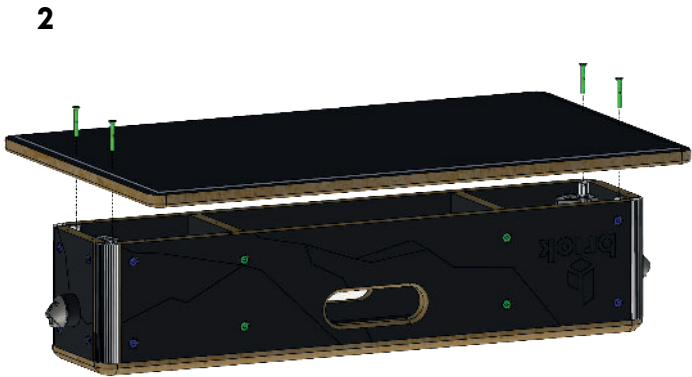
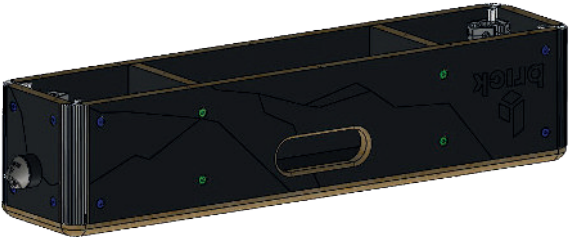
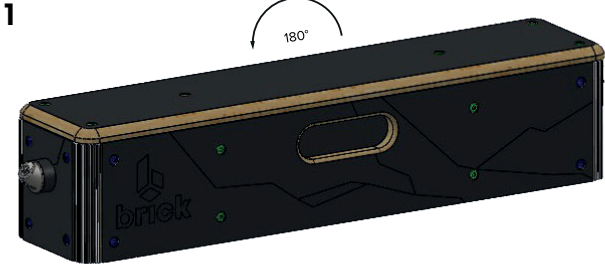
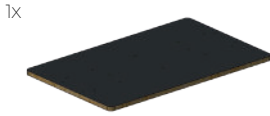
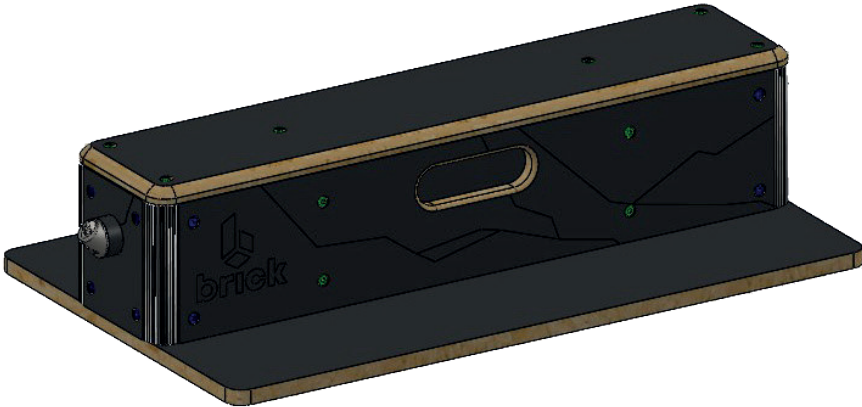

ASSEMBLY KEY

Réf.
51000101

Dimensions (mm)
∅

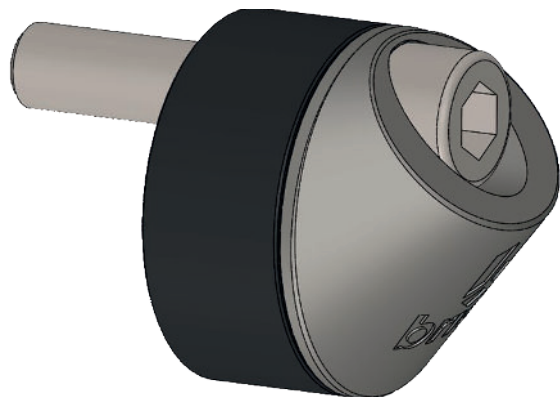

CONTENU DU KIT

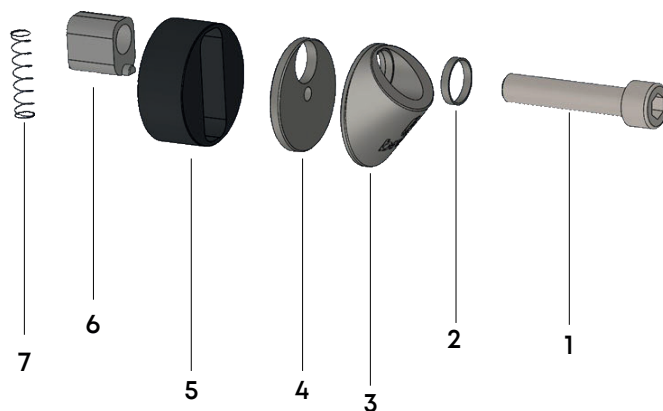

1

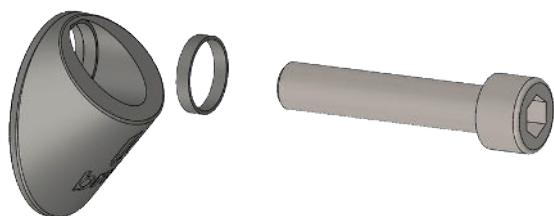

2

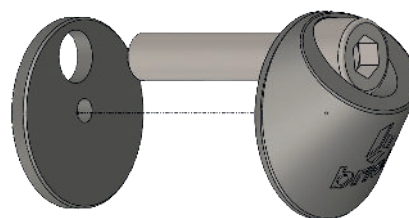

3

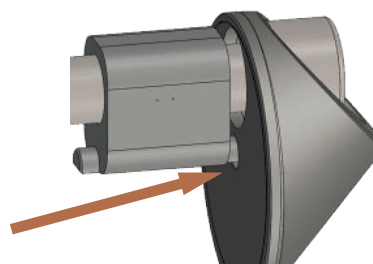
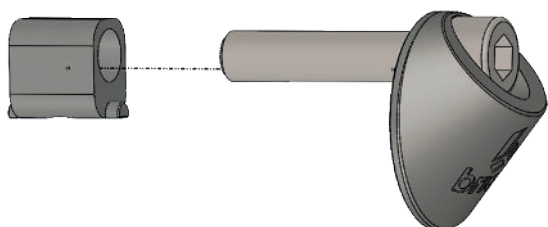

4

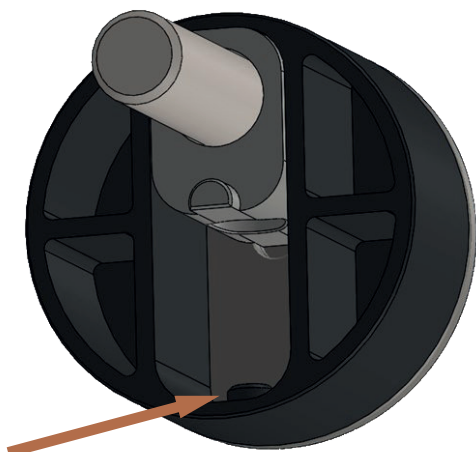

5

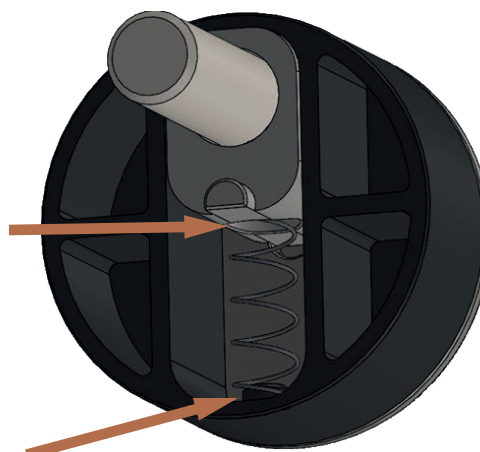

KEY HANDLE L

Réf.
23005226

Dimensions (mm)
620



1.

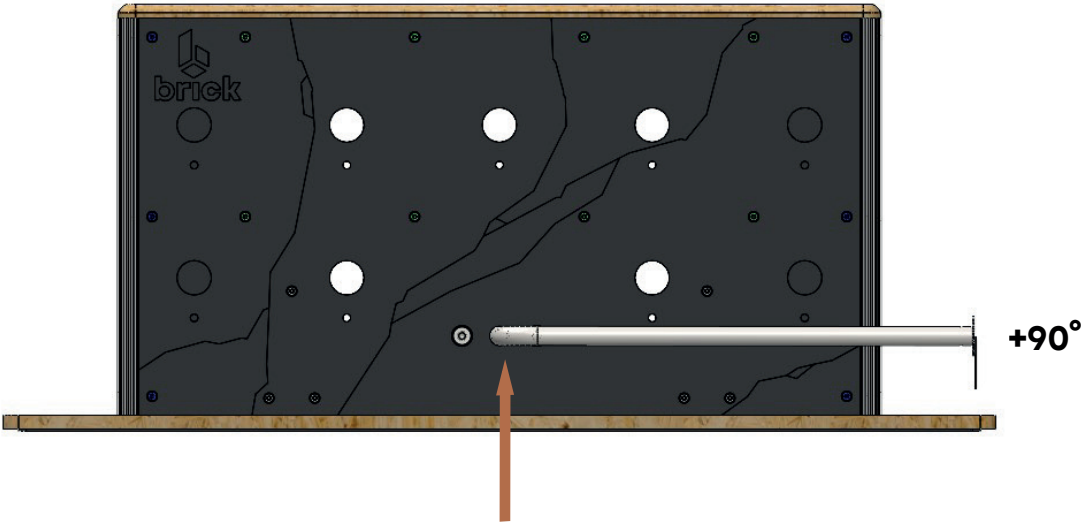

2.

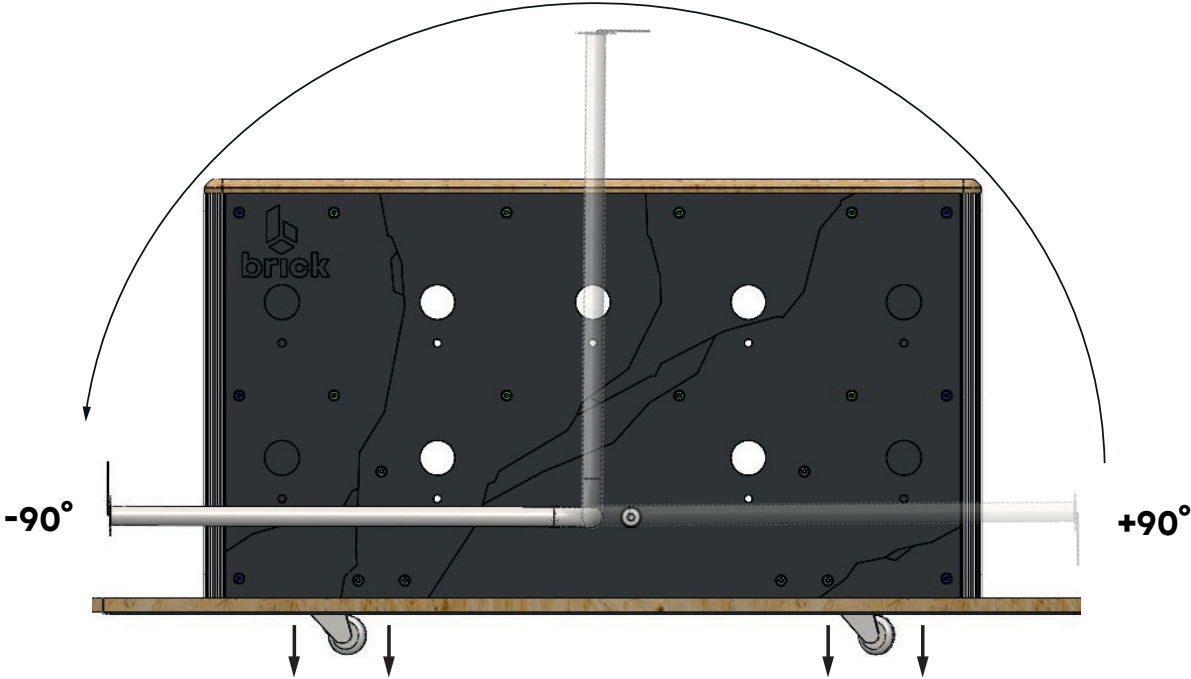





brick

brick



MODULES
À L'UNITÉ
ET
ACCESSOIRES

Scanne ce QR Code
pour accéder à notre
SITE WEB

brickparkour.com



NOTICE DE
MONTAGE